

为 您 的 产 品 保 驾 护 航

PRODUCT DATASHEET

Surface Mount PTC Devices

ASMD0805 Series Surface Mount PTC Devices

Description

The ASMD0805 series is suitable for ultra portable applications where space is at a premium and the device current is low.



Features



- RoHS compliant and lead-free
- Low profile
- Halogen-free
- Fast response to fault current
- Compact design saves board space
- Compatible with high temperature solders

Agency Approvals

Agency	File Number
	E472196

Applications

- Mobile phones and PDAs
- IC VCC protection
- Portable MP3 and media player
- Set-top-box and HDMI
- Mobile Internet Device (MID)
- Game console port protection
- USB peripherals

Regulation	Standard
	2002/95/EC
	EN14582

Performance Specification

Model	V _{max} (V dc)	I _{max} (A)	I _{hold} @25°C (A)	I _{trip} @25°C (A)	P _d Typ. (W)	Maximum Time To Trip		Resistance	
						Current (A)	Time (Sec)	R _{i min} (Ω)	R _{1max} (Ω)
ASMD0805-001-60V	60.0	30	0.01	0.05	0.5	0.15	1.50	12.0	100.0
ASMD0805-003	30.0	40	0.03	0.09	0.5	0.1	1.50	6.00	50.00
ASMD0805-005	15.0	100	0.05	0.15	0.5	0.5	1.50	1.50	20.00
ASMD0805-005-24V	24.0	100	0.05	0.15	0.5	0.5	1.50	1.50	20.00
ASMD0805-010	15.0	100	0.10	0.30	0.5	0.5	1.50	0.75	6.000
ASMD0805-010-30V	30.0	100	0.10	0.30	0.5	0.5	1.50	0.75	6.000
ASMD0805-010-60V	60.0	40	0.10	0.25	0.5	0.5	1.50	1.00	9.000
ASMD0805-020	9.00	100	0.20	0.50	0.5	8.0	0.02	0.50	3.500
ASMD0805-020-16V	16.0	100	0.20	0.50	0.5	8.0	0.02	0.50	3.500
ASMD0805-035	6.00	100	0.35	0.75	0.5	8.0	0.10	0.20	1.200
ASMD0805-035-12V	12.0	100	0.35	0.75	0.5	8.0	0.10	0.20	1.200
ASMD0805-050	6.00	100	0.50	1.00	0.5	8.0	0.10	0.10	0.850
ASMD0805-050-12V	12.0	100	0.50	1.00	0.5	8.0	0.10	0.10	0.850
ASMD0805-050-16V	16.0	100	0.50	1.00	0.5	8.0	0.10	0.10	0.850
ASMD0805-050-24V	24.0	100	0.50	1.00	0.5	8.0	0.10	0.10	0.850
ASMD0805-050-30V	30.0	40	0.50	1.00	0.5	8.0	0.10	0.15	0.850
ASMD0805-075	6.00	100	0.75	1.50	0.6	8.0	0.20	0.07	0.385
ASMD0805-075-12V	12.0	100	0.75	1.50	0.6	8.0	0.20	0.07	0.385
ASMD0805-100	6.00	100	1.00	1.95	0.6	8.0	0.30	0.04	0.230
ASMD0805-100-12V	12.0	100	1.00	1.95	0.6	8.0	0.30	0.04	0.230
ASMD0805-110	6.00	100	1.10	2.20	0.6	8.0	0.30	0.035	0.210
ASMD0805-110-12V	12.0	100	1.10	2.20	0.6	8.0	0.30	0.035	0.210
ASMD0805-125	6.00	100	1.25	2.50	1.5	8.0	0.60	0.025	0.140
ASMD0805-150	6.00	100	1.50	3.00	1.0	8.0	0.50	0.015	0.130

I_{hold} = Hold Current. Maximum current device will not trip in 25°C still air.

I_{trip} = Trip Current. Minimum current at which the device will always trip in 25°C still air.

V_{max} = Maximum operating voltage device can withstand without damage at rated current (I_{max}).

I_{max} = Maximum fault current device can withstand without damage at rated voltage (V_{max}).

P_d = Power dissipation when device is in the tripped state in 25°C still air environment at rated voltage.

R_{i min/max} = Minimum/Maximum device resistance prior to tripping at 25°C.

R_{1max} = Maximum device resistance is measured one hour post reflow.

CAUTION : Operation beyond the specified ratings may result in damage and possible arcing and flame.

Environmental Specifications

Test	Conditions	Resistance change
Passive aging	+85°C, 1000 hrs.	±5% typical
Humidity aging	+85°C, 85% R.H. , 168 hours	±5% typical
Thermal shock	+85°C to -40°C, 20 times	±33% typical
Resistance to solvent	MIL-STD-202, Method 215	No change
Vibration	MIL-STD-202, Method 201	No change
Ambient operating conditions : - 40 °C to +85 °C		
Maximum surface temperature of the device in the tripped state is 125 °C		

Thermal Derating Curve

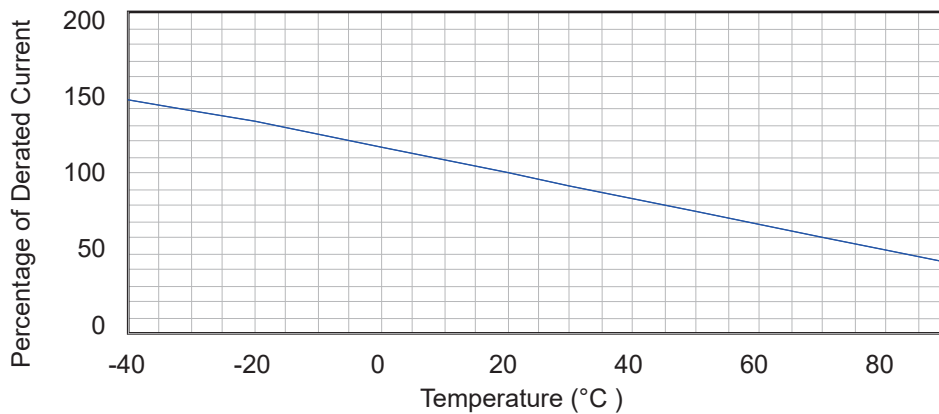

Average Time-Current Curve

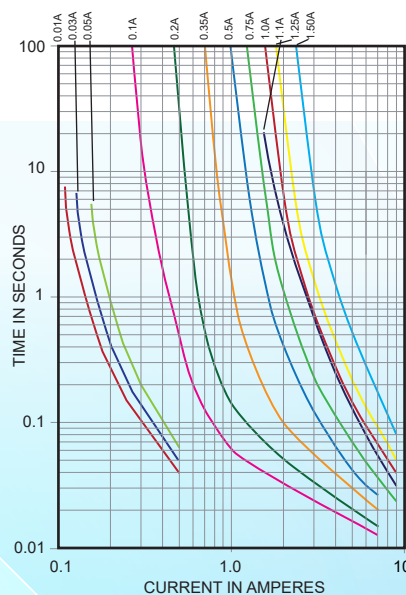

Thermal Derating Chart

Model	Maximum ambient operating temperature (T_{mao}) vs. hold current (I_{hold})								
	- 40°C	- 20°C	0°C	25°C	40°C	50°C	60°C	70°C	85°C
ASMD0805-001	0.016	0.014	0.012	0.010	0.008	0.0075	0.0065	0.0055	0.004
ASMD0805-003	0.044	0.039	0.036	0.030	0.026	0.024	0.021	0.020	0.017
ASMD0805-005	0.070	0.060	0.055	0.050	0.040	0.035	0.030	0.025	0.015
ASMD0805-010	0.140	0.120	0.110	0.100	0.080	0.070	0.060	0.050	0.030
ASMD0805-020	0.280	0.250	0.230	0.200	0.170	0.140	0.120	0.100	0.070
ASMD0805-035	0.470	0.440	0.390	0.350	0.300	0.270	0.240	0.200	0.140
ASMD0805-050	0.680	0.620	0.550	0.500	0.400	0.370	0.330	0.290	0.230
ASMD0805-075	1.000	0.900	0.790	0.750	0.630	0.570	0.530	0.410	0.340
ASMD0805-100	1.350	1.250	1.150	1.000	0.820	0.740	0.650	0.550	0.420
ASMD0805-110	1.450	1.350	1.200	1.100	0.920	0.840	0.750	0.650	0.520
ASMD0805-125	1.650	1.530	1.360	1.250	1.050	0.950	0.850	0.740	0.590
ASMD0805-150	1.980	1.840	1.630	1.500	1.260	1.140	1.020	0.880	0.710

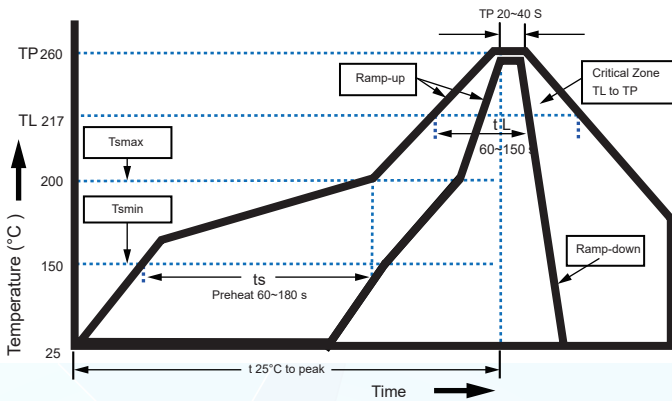
Soldering Parameters

- Recommended reflow methods: IR, vapor phase oven, hot air oven, N2 environment for lead-free.
- Recommended maximum paste thickness is 0.25mm. Devices can be cleaned using standard industry methods and solvents.
- Note 1: All temperature refer to topside of the package, measured on the package body surface.
- Note 2: If reflow temperatures exceed the recommended profile, devices may not meet the performance requirements.

Profile Feature
Pb-Free Assembly

Average Ramp-Up Rate (Ts max to T p) **3°C/second mac.**

Preheat

-Temperature Min(Ts min) **150°C**
 -Temperature Max(Ts max) **200°C**
 -Time(Ts min to Ts max) **60~180 seconds**

Time maintained above:

-Temperature(TL) **217°C**
 -Time(tL) **60~150 seconds**

Peak Temperature(Tp) **260°C**

Ramp-Down Rate **6°C/second max.**

Time 25°C to Peak Temperature **8 minutes max**

Storage And Handling:

Storage conditions **0°C~ 35°C, 30% ~60%R.H.**

Devices may not meet specified performance if storage conditions are exceeded.

Physical Dimensions(mm.)

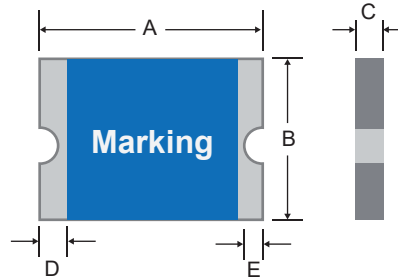

Model	A		B		C		D	E
	Min.	Max.	Min.	Max.	Min.	Max.	Min.	Min.
ASMD0805-001-60V	2.0	2.3	1.2	1.5	0.40	0.9	0.2	0.1
ASMD0805-003	2.0	2.3	1.2	1.5	0.40	0.9	0.2	0.1
ASMD0805-005	2.0	2.3	1.2	1.5	0.35	1.1	0.2	0.1
ASMD0805-005-24V	2.0	2.3	1.2	1.5	0.35	1.1	0.2	0.1
ASMD0805-010	2.0	2.3	1.2	1.5	0.35	1.1	0.2	0.1
ASMD0805-010-30V	2.0	2.3	1.2	1.5	0.35	1.1	0.2	0.1
ASMD0805-010-60V	2.0	2.3	1.2	1.5	0.65	1.15	0.2	0.1
ASMD0805-020	2.0	2.3	1.2	1.5	0.35	1.1	0.2	0.1
ASMD0805-020-16V	2.0	2.3	1.2	1.5	0.35	1.1	0.2	0.1
ASMD0805-035	2.0	2.3	1.2	1.5	0.35	1.1	0.2	0.1
ASMD0805-035-12V	2.0	2.3	1.2	1.5	0.35	1.1	0.2	0.1
ASMD0805-050	2.0	2.3	1.2	1.5	0.35	1.1	0.2	0.1
ASMD0805-050-12V	2.0	2.3	1.2	1.5	0.35	1.1	0.2	0.1
ASMD0805-050-16V	2.0	2.3	1.2	1.5	0.35	1.1	0.2	0.1
ASMD0805-050-24V	2.0	2.3	1.2	1.5	0.35	1.1	0.2	0.1
ASMD0805-050-30V	2.0	2.3	1.2	1.5	0.65	0.15	0.2	0.1
ASMD0805-075	2.0	2.3	1.2	1.5	0.35	1.0	0.2	0.1
ASMD0805-075-12V	2.0	2.3	1.2	1.5	0.35	1.0	0.2	0.1
ASMD0805-100	2.0	2.3	1.2	1.5	0.70	1.2	0.2	0.1
ASMD0805-100-12V	2.0	2.3	1.2	1.5	0.70	1.2	0.2	0.1
ASMD0805-110	2.0	2.3	1.2	1.5	0.70	1.2	0.2	0.1
ASMD0805-110-12V	2.0	2.3	1.2	1.5	0.70	1.2	0.2	0.1
ASMD0805-125	2.0	2.3	1.2	1.5	0.70	1.5	0.2	0.1
ASMD0805-150	2.0	2.3	1.2	1.5	0.70	1.5	0.2	0.1

Termination Pad Characteristics

Terminal pad materials: Tin-plated Nickel-Copper

Terminal pad solder ability: Meets EIA specification RS186-9E and ANSI/J-STD-002 Category 3

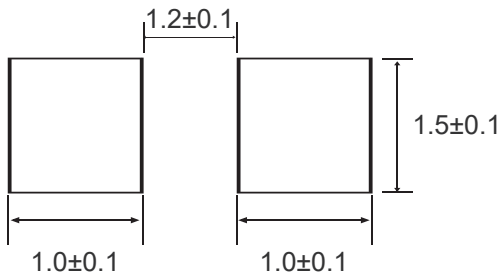
Recommended Pad Layout and Packaging Quantity

Part Number	Quantity
ASMD0805-001-60V~050	5,000 pcs/reel
ASMD0805-050-30V~125	4,000 pcs/reel
ASMD0805-150	3,500 pcs/reel
Tape & reel packaging per EIA481-1	

Tape And Reel Specifications (mm)

Governing Specifications	EIA 481-1
W	8.00 ± 0.10
F	3.50 ± 0.05
E1	1.75 ± 0.10
D0	1.55 ± 0.05
D1	1.0 Min
P0	4.00 ± 0.10
P1	4.00 ± 0.10
P2	2.00 ± 0.05
A0	1.70 ± 0.10
B0	2.45 ± 0.10
T	0.20 ± 0.05
K0	0.80/0.95± 0.10
Leader	390 mm
Trailer	160 mm

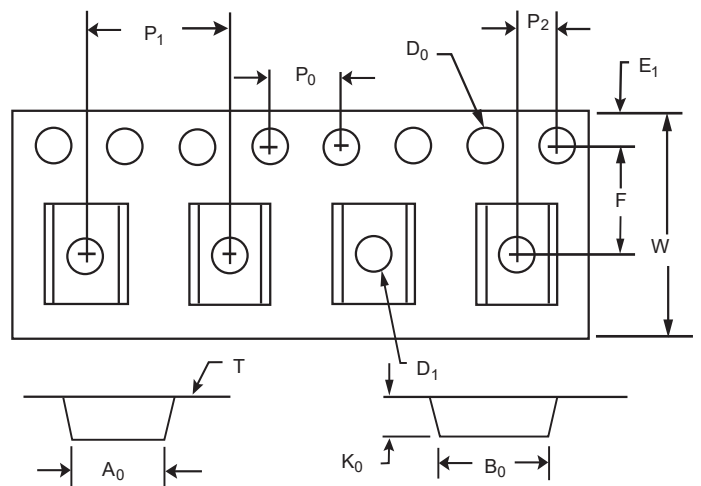
REEL DIMENSIONS: EIA-481-1(mm)

C	φ 178 ± 1.0
D	φ 60.2 ± 0.5
W	9.0 ± 1.5
H	11.0 ± 0.5

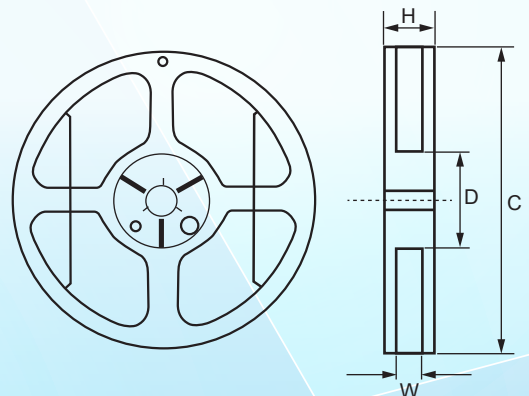

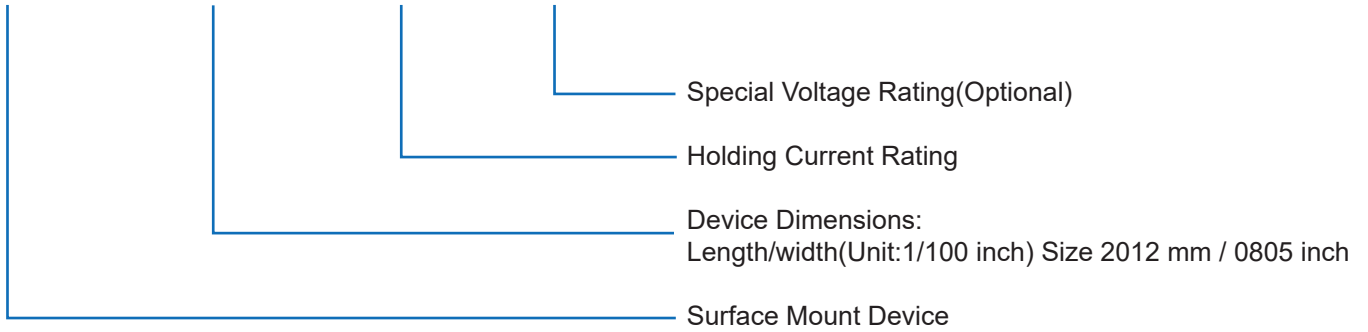
Part Number System
ASMD 0805 - □□□ - □□

Cross Reference

Model	Cross Reference		
	Tyco / PolySwitch®	Littelfuse / POLY-FUSE®	Polytronics / EVERFUSE®
ASMD0805-010	-	0805L010	SMD0805P010TF
ASMD0805-020	-	0805L020	SMD0805P020TF
ASMD0805-035	picoSMDC035F	0805L035	SMD0805P035TF
ASMD0805-050	-	0805L050	SMD0805P050TF
ASMD0805-075	-	0805L075	SMD0805P075TF
ASMD0805-100	-	0805L100	SMD0805P100TF
ASMD0805-100-12	-	0805L100/12	SMD0805P100TF/12
ASMD0805-110	-	0805L110	SMD0805P110TF
ASMD0805-125	-	-	-

“PolySwitch” is a registered trademark of Tyco Electronics.

“POLY-FUSE” is a registered trademark of Littelfuse, Inc.

“EVERFUSE” is a registered trademark of Polytronics Technology Corp.

Application Notice

1. Operation of these PPTC devices beyond the stated maximum ratings could result in damage to the devices and lead to electrical arcing and/or fire;

PPTC 器件在超过规定的最大值额定值运行可能会导致器件损坏以及导致电弧和/或火灾。

2. These PPTC devices are intended to protect against the effects of temporary over-current or over-temperature conditions and shall not be taken for use as switch.

PPTC 的作用是防止临时的过流或过温造成的不良影响，不能当作开关使用。

3. Exposure to lubricants, silicon-based oils, solvents, gels, electrolytes, acids, and other related or similar materials may adversely affect the performance of PPTC devices.

PPTC 接触润滑剂、硅基油、溶剂、凝胶、电解质、酸和其他相关或类似材料可能会对 PPTC 器件的性能有不利影响。

4. Circuits with inductance may generate a voltage above the rated voltage of the PPTC device and should be thoroughly evaluated within the user's application during the PPTC selection and qualification process.

带有电感的电路可能产生高于 PPTC 额定电压的电压，因此客户在选型和认定过程中应进行彻底的评估。

5. Please do not smash, clamp, pull, dent or twist by tool during assembling process, as they may result in the PPTC damage.

在装配过程中，避免有砸、挤、拉、扭等方式外力作用于 PPTC 本体上，因为它们可能导致 PPTC 损坏。

6. Hand-soldering of PPTC devices on boards is generally not recommended. Users shall define and verify this process if needed.

不推荐使用手工焊接的方式焊接 PPTC。如果需要，用户需要定义和验证此过程。

7. Recommended storage conditions should be followed at all times, The MSL classification of PPTC is grade 2a.

必须始终遵守推荐的保存条件要求，PPTC 的 MSL 等级为 2 a 级。