

为您的产品保驾护航

PRODUCT DATASHEET

PTC Devices • Surface Mount

ASMD1206 Series Surface Mount PTC Devices



Description

The ASMD1206 series provides miniature surface mount overcurrent protection with holding current from 0.05A to 3.5A.

This series is suitable for wide range of applications in modern electronics where space is limited.

Features



- RoHS compliant and lead-free
- Low profile
- Halogen-free
- Fast response to fault current
- Compact design saves board space
- Compatible with high temperature solders

Agency Approvals

| Agency | File Number |
|---|-------------|
|  | E472196 |

Applications

- Battery PCM
- Game console port protection
- USB hubs, ports and peripherals
- Optical disk drives
- Set-top-box and HDMI
- General electronics

| Regulation | Standard |
|---|------------|
|  | 2002/95/EC |
|  | EN14582 |

Performance Specification TABLE I.

| Model | V _{max} (V dc) | I _{max} (A) | I _{hold} @25°C (A) | I _{trip} @25°C (A) | P _d Typ. (W) | Maximum Time To Trip | | Resistance | |
|--------------------|----------------------------|-------------------------|-----------------------------------|-----------------------------------|-------------------------------|-------------------------|---------------|---------------------------|--------------------------|
| | | | | | | Current (A) | Time (Sec) | R _{i min} (Ω) | R _{1max} (Ω) |
| ASMD1206-005 | 60.0 | 100 | 0.05 | 0.15 | 0.4 | 0.25 | 1.5 | 3.60 | 50 |
| ASMD1206-005-24V | 24.0 | 100 | 0.05 | 0.15 | 0.4 | 0.25 | 1.5 | 3.60 | 50 |
| ASMD1206-010 | 60.0 | 100 | 0.1 | 0.25 | 0.4 | 0.5 | 1.0 | 1.60 | 15 |
| ASMD1206-010-24V | 24.0 | 100 | 0.1 | 0.25 | 0.4 | 0.5 | 1.0 | 1.60 | 15 |
| ASMD1206-012 | 60.0 | 100 | 0.12 | 0.29 | 0.4 | 0.5 | 1.0 | 1.60 | 15 |
| ASMD1206-012-24V | 24.0 | 100 | 0.12 | 0.29 | 0.4 | 0.5 | 1.0 | 1.60 | 15 |
| ASMD1206-016 | 16.0 | 100 | 0.16 | 0.37 | 0.4 | 1.0 | 0.3 | 1.00 | 6.0 |
| ASMD1206-016-24V | 24.0 | 100 | 0.16 | 0.37 | 0.4 | 1.0 | 0.3 | 1.00 | 6.0 |
| ASMD1206-016-33V | 33.0 | 100 | 0.16 | 0.37 | 0.4 | 1.0 | 0.3 | 1.00 | 6.0 |
| ASMD1206-020 | 24.0 | 100 | 0.2 | 0.46 | 0.6 | 8.0 | 0.08 | 0.35 | 3.5 |
| ASMD1206-020-30V | 30.0 | 100 | 0.2 | 0.46 | 0.6 | 8.0 | 0.08 | 0.35 | 3.5 |
| ASMD1206-020-48V | 48.0 | 100 | 0.2 | 0.46 | 0.6 | 8.0 | 0.08 | 0.35 | 3.5 |
| ASMD1206-025 | 16.0 | 100 | 0.25 | 0.5 | 0.6 | 8.0 | 0.08 | 0.35 | 2.7 |
| ASMD1206-025-24V | 24.0 | 100 | 0.25 | 0.5 | 0.6 | 8.0 | 0.08 | 0.35 | 2.7 |
| ASMD1206-025-30V | 30.0 | 100 | 0.25 | 0.5 | 0.6 | 8.0 | 0.08 | 0.35 | 2.7 |
| ASMD1206-025-48V | 48.0 | 100 | 0.25 | 0.5 | 0.6 | 8.0 | 0.08 | 0.35 | 2.7 |
| ASMD1206-035 | 6.0 | 100 | 0.35 | 0.75 | 0.6 | 8.0 | 0.1 | 0.25 | 1.5 |
| ASMD1206-035-16V | 16.0 | 100 | 0.35 | 0.75 | 0.6 | 8.0 | 0.1 | 0.25 | 1.5 |
| ASMD1206-035-30V | 30.0 | 100 | 0.35 | 0.75 | 0.6 | 8.0 | 0.1 | 0.25 | 1.5 |
| ASMD1206-050 | 6.0 | 100 | 0.5 | 1.0 | 0.6 | 8.0 | 0.1 | 0.15 | 0.7 |
| ASMD1206-050-13.2V | 13.2 | 100 | 0.5 | 1.0 | 0.6 | 8.0 | 0.1 | 0.15 | 0.7 |
| ASMD1206-050-16V | 16.0 | 100 | 0.5 | 1.0 | 0.6 | 8.0 | 0.1 | 0.15 | 0.7 |
| ASMD1206-050-30V | 30.0 | 100 | 0.5 | 1.0 | 0.6 | 8.0 | 0.1 | 0.15 | 0.7 |
| ASMD1206-075 | 6.0 | 100 | 0.75 | 1.5 | 0.6 | 8.0 | 0.2 | 0.09 | 0.5 |
| ASMD1206-075-16V | 16.0 | 100 | 0.75 | 1.5 | 0.6 | 8.0 | 0.2 | 0.09 | 0.5 |
| ASMD1206-075-30V | 30.0 | 100 | 0.75 | 1.5 | 0.6 | 8.0 | 0.2 | 0.09 | 0.5 |
| ASMD1206-100 | 6.0 | 100 | 1.0 | 1.8 | 0.6 | 8.0 | 0.3 | 0.05 | 0.27 |
| ASMD1206-100-16V | 16.0 | 100 | 1.0 | 1.8 | 0.6 | 8.0 | 0.3 | 0.05 | 0.27 |
| ASMD1206-100-24V | 24.0 | 100 | 1.0 | 1.8 | 0.6 | 8.0 | 0.3 | 0.05 | 0.27 |
| ASMD1206-110 | 6.0 | 100 | 1.1 | 2.2 | 0.6 | 8.0 | 0.3 | 0.04 | 0.25 |
| ASMD1206-110-16V | 16.0 | 100 | 1.1 | 2.2 | 0.6 | 8.0 | 0.3 | 0.04 | 0.25 |
| ASMD1206-110-24V | 24.0 | 100 | 1.1 | 2.2 | 0.6 | 8.0 | 0.3 | 0.04 | 0.25 |
| ASMD1206-150 | 6.0 | 100 | 1.5 | 3.0 | 0.8 | 8.0 | 0.3 | 0.025 | 0.13 |
| ASMD1206-150-13.2V | 13.2 | 100 | 1.5 | 3.0 | 0.8 | 8.0 | 0.3 | 0.025 | 0.13 |

Performance Specification TABLE II.

| Model | V _{max} (V dc) | I _{max} (A) | I _{hold} @25°C (A) | I _{trip} @25°C (A) | P _d Typ. (W) | Maximum Time To Trip | | Resistance | |
|------------------|----------------------------|-------------------------|-----------------------------------|-----------------------------------|-------------------------------|----------------------|---------------|---------------------------|--------------------------|
| | | | | | | Current (A) | Time (Sec) | R _{i min} (Ω) | R _{1max} (Ω) |
| ASMD1206-200 | 6.0 | 100 | 2.0 | 3.5 | 0.8 | 8.0 | 1.5 | 0.015 | 0.08 |
| ASMD1206-200-12V | 12.0 | 100 | 2.0 | 3.5 | 0.8 | 8.0 | 1.5 | 0.015 | 0.08 |
| ASMD1206-200-16V | 16.0 | 50 | 2.0 | 3.5 | 0.8 | 8.0 | 1.5 | 0.015 | 0.08 |
| ASMD1206-260 | 6.0 | 100 | 2.6 | 5.2 | 0.8 | 8.0 | 2.0 | 0.01 | 0.06 |
| ASMD1206-300 | 6.0 | 100 | 3.0 | 6.0 | 1.0 | 8.0 | 4.0 | 0.01 | 0.05 |
| ASMD1206-350 | 6.0 | 100 | 3.5 | 7.0 | 1.2 | 10.0 | 5.0 | 0.005 | 0.04 |

I_{hold} = Hold Current. Maximum current device will not trip in 25°C still air.

I_{trip} = Trip Current. Minimum current at which the device will always trip in 25°C still air.

V_{max} = Maximum operating voltage device can withstand without damage at rated current (I_{max}).

I_{max} = Maximum fault current device can withstand without damage at rated voltage (V_{max}).

P_d = Power dissipation when device is in the tripped state in 25°C still air environment at rated voltage.

R_{i min/max} = Minimum/Maximum device resistance prior to tripping at 25°C.

R_{1max} = Maximum device resistance is measured one hour post reflow.

CAUTION : Operation beyond the specified ratings may result in damage and possible arcing and flame.

Environmental Specifications

| Test | Conditions | Resistance change |
|-----------------------|-----------------------------|-------------------|
| Passive aging | +85°C, 1000 hrs. | ±5% typical |
| Humidity aging | +85°C, 85% R.H. , 168 hours | ±5% typical |
| Thermal shock | +85°C to -40°C, 20 times | ±33% typical |
| Resistance to solvent | MIL-STD-202,Method 215 | No change |
| Vibration | MIL-STD-202,Method 201 | No change |

Ambient operating conditions : - 40 °C to +85 °C

Maximum surface temperature of the device in the tripped state is 125 °C

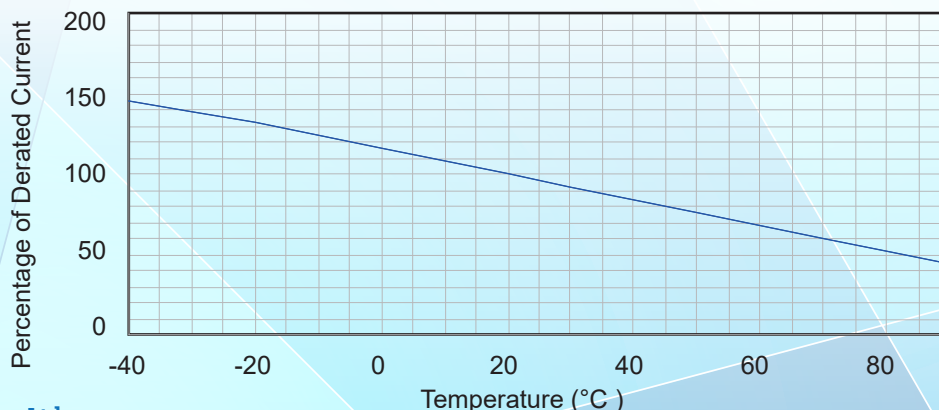
Thermal Derating Curve

Average Time-Current Curve

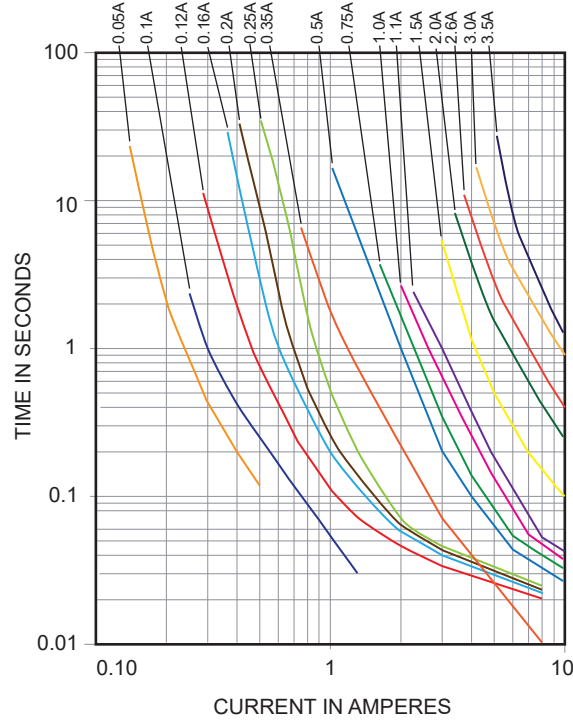

Thermal Derating Chart

| Model | Maximum ambient operating temperature (T_{mac}) vs. hold current (I_{hold}) | | | | | | | | |
|--------------|---|--------|-------|------|--------|--------|-------|------|--------|
| | - 40°C | - 20°C | 0°C | 25°C | 40°C | 50°C | 60°C | 70°C | 85°C |
| ASMD1206-005 | 0.074 | 0.066 | 0.058 | 0.05 | 0.0425 | 0.0375 | 0.035 | 0.03 | 0.0275 |
| ASMD1206-010 | 0.148 | 0.132 | 0.116 | 0.10 | 0.085 | 0.075 | 0.07 | 0.06 | 0.055 |
| ASMD1206-012 | 0.18 | 0.16 | 0.14 | 0.12 | 0.10 | 0.09 | 0.08 | 0.07 | 0.07 |
| ASMD1206-016 | 0.24 | 0.21 | 0.18 | 0.16 | 0.14 | 0.13 | 0.12 | 0.11 | 0.10 |
| ASMD1206-020 | 0.30 | 0.26 | 0.23 | 0.20 | 0.17 | 0.15 | 0.14 | 0.12 | 0.11 |
| ASMD1206-025 | 0.37 | 0.33 | 0.29 | 0.25 | 0.22 | 0.20 | 0.17 | 0.15 | 0.12 |
| ASMD1206-035 | 0.50 | 0.45 | 0.40 | 0.35 | 0.30 | 0.27 | 0.24 | 0.21 | 0.15 |
| ASMD1206-050 | 0.71 | 0.64 | 0.57 | 0.50 | 0.42 | 0.39 | 0.35 | 0.31 | 0.25 |
| ASMD1206-075 | 1.14 | 1.01 | 0.88 | 0.75 | 0.65 | 0.59 | 0.54 | 0.49 | 0.41 |
| ASMD1206-100 | 1.45 | 1.31 | 1.15 | 1.00 | 0.84 | 0.77 | 0.69 | 0.61 | 0.48 |
| ASMD1206-110 | 1.60 | 1.45 | 1.30 | 1.10 | 0.95 | 0.80 | 0.72 | 0.66 | 0.55 |
| ASMD1206-150 | 2.18 | 1.94 | 1.72 | 1.50 | 1.28 | 1.17 | 1.06 | 0.96 | 0.77 |
| ASMD1206-200 | 2.88 | 2.63 | 2.34 | 2.00 | 1.74 | 1.58 | 1.42 | 1.17 | 0.93 |
| ASMD1206-260 | 3.43 | 3.22 | 2.93 | 2.60 | 2.23 | 2.03 | 1.87 | 1.57 | 1.35 |
| ASMD1206-300 | 4.05 | 3.66 | 3.36 | 3.00 | 2.50 | 2.28 | 2.00 | 1.62 | 1.35 |
| ASMD1206-350 | 4.65 | 4.23 | 3.92 | 3.50 | 2.92 | 2.68 | 2.35 | 1.91 | 1.42 |

Soldering Parameters

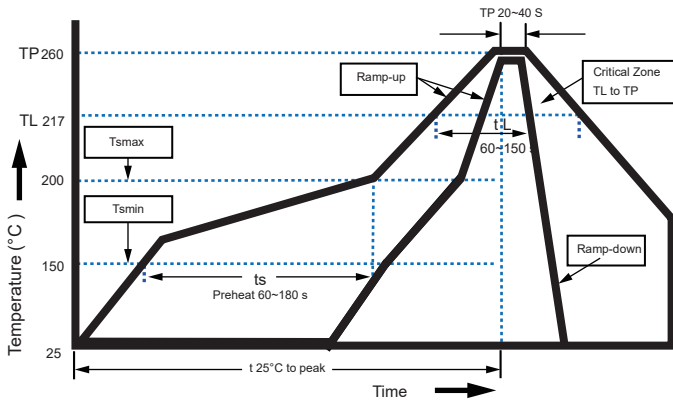

Profile Feature

Pb-Free Assembly

Average Ramp-Up Rate 3°C/second mac.
(Ts max to T p)

Preheat

| | |
|--------------------------|----------------|
| -Temperature Min(Ts min) | 150°C |
| -Temperature Max(Ts max) | 200°C |
| -Time(Ts min to Ts max) | 60~180 seconds |

Time maintained above:

| | |
|------------------|----------------|
| -Temperature(TL) | 217°C |
| -Time(tL) | 60~150 seconds |

Peak Temperature(Tp) 260°C

Ramp-Down Rate 6°C/second max.

Time 25°C to Peak Temperature 8 minutes max

Storage And Handling:

Storage conditions 0°C~ 35°C,30% ~60%R.H.
Devices may not meet specified performance if storage conditions are exceeded.

- Recommended reflow methods: IR, vapor phase oven, hot air oven, N2 environment for lead-free.
- Recommended maximum paste thickness is 0.25mm
Devices can be cleaned using standard industry methods and solvents.
- Note 1:All temperature refer to topside of the package, measured on the package body surface.
- Note 2: If reflow temperatures exceed the recommended profile, devices may not meet the performance requirements.

Physical Dimensions(mm.)

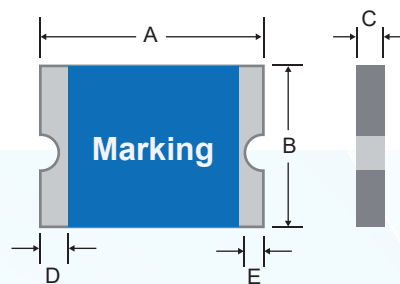

Termination Pad Characteristics

Terminal pad materials: Tin-plated Nickel-Copper

Terminal pad solder ability: Meets EIA specification RS186-9E and ANSI/J-STD-002 Category 3

| Model | A | | B | | C | | D | E |
|--------------------|------|------|------|------|------|------|------|------|
| | Min. | Max. | Min. | Max. | Min. | Max. | Min. | Min. |
| ASMD1206-005 | 3.0 | 3.6 | 1.5 | 1.9 | 0.6 | 1.2 | 0.15 | 0.1 |
| ASMD1206-010 | 3.0 | 3.6 | 1.5 | 1.9 | 0.6 | 1.2 | 0.15 | 0.1 |
| ASMD1206-012 | 3.0 | 3.6 | 1.5 | 1.9 | 0.6 | 1.2 | 0.15 | 0.1 |
| ASMD1206-016 | 3.0 | 3.6 | 1.5 | 1.9 | 0.4 | 1.0 | 0.15 | 0.1 |
| ASMD1206-020 | 3.0 | 3.6 | 1.5 | 1.9 | 0.4 | 1.0 | 0.15 | 0.1 |
| ASMD1206-020-30V | 3.0 | 3.6 | 1.5 | 1.9 | 0.4 | 1.0 | 0.15 | 0.1 |
| ASMD1206-020-48V | 3.0 | 3.6 | 1.5 | 1.9 | 0.4 | 1.0 | 0.15 | 0.1 |
| ASMD1206-025 | 3.0 | 3.6 | 1.5 | 1.9 | 0.4 | 1.0 | 0.15 | 0.1 |
| ASMD1206-025-30V | 3.0 | 3.6 | 1.5 | 1.9 | 0.4 | 1.0 | 0.15 | 0.1 |
| ASMD1206-025-48V | 3.0 | 3.6 | 1.5 | 1.9 | 0.4 | 1.0 | 0.15 | 0.1 |
| ASMD1206-035 | 3.0 | 3.6 | 1.5 | 1.9 | 0.35 | 0.8 | 0.15 | 0.1 |
| ASMD1206-035-16V | 3.0 | 3.6 | 1.5 | 1.9 | 0.35 | 0.8 | 0.15 | 0.1 |
| ASMD1206-035-30V | 3.0 | 3.6 | 1.5 | 1.9 | 0.4 | 0.9 | 0.15 | 0.1 |
| ASMD1206-050 | 3.0 | 3.6 | 1.5 | 1.9 | 0.35 | 0.8 | 0.15 | 0.1 |
| ASMD1206-050-13.2V | 3.0 | 3.6 | 1.5 | 1.9 | 0.35 | 0.8 | 0.15 | 0.1 |
| ASMD1206-050-16V | 3.0 | 3.6 | 1.5 | 1.9 | 0.35 | 0.8 | 0.15 | 0.1 |
| ASMD1206-050-30V | 3.0 | 3.6 | 1.5 | 1.9 | 0.5 | 1.0 | 0.15 | 0.1 |
| ASMD1206-075 | 3.0 | 3.6 | 1.5 | 1.9 | 0.35 | 0.8 | 0.15 | 0.1 |
| ASMD1206-075-16V | 3.0 | 3.6 | 1.5 | 1.9 | 0.5 | 1.0 | 0.15 | 0.1 |
| ASMD1206-075-30V | 3.0 | 3.6 | 1.5 | 1.9 | 0.5 | 1.0 | 0.15 | 0.1 |
| ASMD1206-100 | 3.0 | 3.6 | 1.5 | 1.9 | 0.35 | 0.8 | 0.15 | 0.1 |
| ASMD1206-100-16V | 3.0 | 3.6 | 1.5 | 1.9 | 0.5 | 1.5 | 0.15 | 0.1 |
| ASMD1206-100-24V | 3.0 | 3.6 | 1.5 | 1.9 | 0.5 | 1.5 | 0.15 | 0.1 |
| ASMD1206-110 | 3.0 | 3.6 | 1.5 | 1.9 | 0.35 | 0.8 | 0.15 | 0.1 |
| ASMD1206-110-16V | 3.0 | 3.6 | 1.5 | 1.9 | 0.5 | 1.5 | 0.15 | 0.1 |
| ASMD1206-110-24V | 3.0 | 3.6 | 1.5 | 1.9 | 0.5 | 1.5 | 0.15 | 0.1 |
| ASMD1206-150 | 3.0 | 3.6 | 1.5 | 1.9 | 0.5 | 1.0 | 0.15 | 0.1 |
| ASMD1206-150-13.2V | 3.0 | 3.6 | 1.5 | 1.9 | 1.0 | 1.6 | 0.15 | 0.1 |
| ASMD1206-200 | 3.0 | 3.6 | 1.5 | 1.9 | 0.7 | 1.6 | 0.15 | 0.1 |
| ASMD1206-200-12V | 3.0 | 3.6 | 1.5 | 1.9 | 0.7 | 1.6 | 0.15 | 0.1 |
| ASMD1206-200-16V | 3.0 | 3.6 | 1.5 | 1.9 | 0.7 | 1.6 | 0.15 | 0.1 |
| ASMD1206-260 | 3.0 | 3.6 | 1.5 | 1.9 | 1.0 | 1.6 | 0.15 | 0.1 |
| ASMD1206-300 | 3.0 | 3.6 | 1.5 | 1.9 | 1.0 | 1.6 | 0.15 | 0.1 |
| ASMD1206-350 | 3.0 | 3.5 | 1.5 | 1.9 | 1.0 | 1.6 | 0.15 | 0.1 |

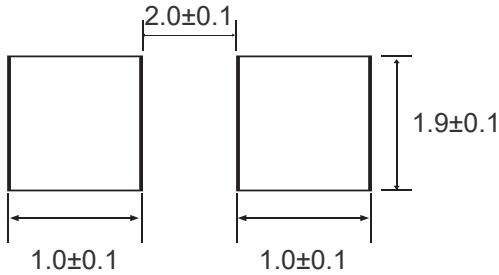
Recommended Pad Layout and Packaging Quantity

| Part Number | Quantity |
|------------------------------------|---------------|
| ASMD1206 | 3500 pcs/reel |
| Tape & reel packaging per EIA481-1 | |

Tape And Reel Specifications (mm)

| Governing Specifications | EIA 481-1 |
|--------------------------|---------------------|
| W | 8.10 ± 0.10 |
| F | 3.50 ± 0.05 |
| E1 | 1.75 ± 0.10 |
| D0 | 1.55 ± 0.05 |
| D1 | 1.0 Min |
| P0 | 4.00 ± 0.10 |
| P1 | 4.00 ± 0.10 |
| P2 | 2.00 ± 0.05 |
| A0 | 1.90± 0.10 |
| B0 | 3.45 ± 0.10 |
| T | 0.25 ± 0.05 |
| K0 | 0.85/1.05/1.3± 0.10 |
| Leader | 390 mm |
| Trailer | 160 mm |

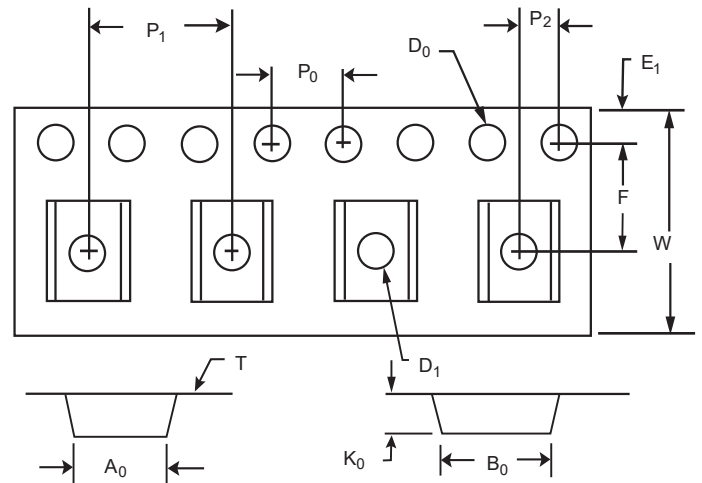

REEL DIMENSIONS: EIA-481-1(mm)

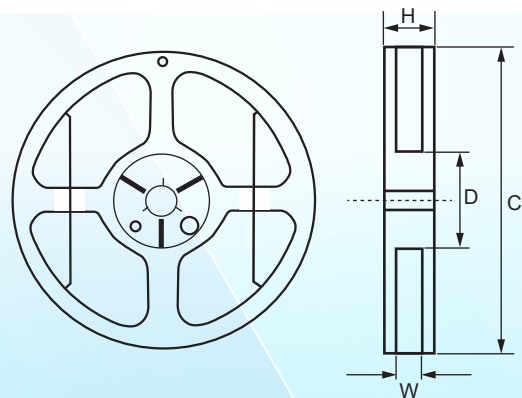
| | |
|---|--------------|
| C | φ 178 ± 1.0 |
| D | φ 60.2 ± 0.5 |
| W | 9.0 ± 1.5 |
| H | 11.0 ± 0.5 |

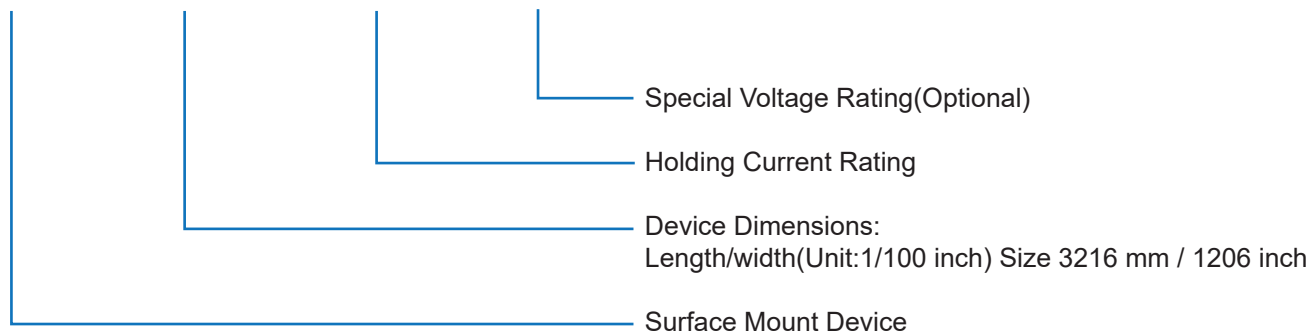

Part Number System

ASMD 1206 - -



Cross Reference

| Model | Cross Reference | | |
|--------------------|--------------------|-------------------------|-------------------------|
| | Tyco / PolySwitch® | Littelfuse / POLY-FUSE® | Polytronics / EVERFUSE® |
| ASMD1206-005 | - | - | - |
| ASMD1206-010 | - | - | - |
| ASMD1206-012 | nanoSMDC012F | 1206L012 | SMD1206P012TF |
| ASMD1206-020 | nanoSMDC020F | 1206L020 | SMD1206P020TF/24 |
| ASMD1206-025 | - | 1206L025 | SMD1206P025TF |
| ASMD1206-035 | nanoSMDC035F | 1206L035 | -SMD1206P035TF |
| ASMD1206-050 | nanoSMDC050F | 1206L050 | SMD1206P050TF |
| ASMD1206-050-13.2V | nanoSMDC050F/13.2 | 1206L050/15 | SMD1206P050TF/15 |
| ASMD1206-075 | nanoSMDC075F | 1206L075 | SMD1206P075TF |
| ASMD1206-075-16V | nanoSMDC075F/16 | 1206L075/16 | SMD1206P075TF/16 |
| ASMD1206-100 | - | - | - |
| ASMD1206-110 | nanoSMDC110F | 1206L110 | SMD1206P110TF |
| ASMD1206-150 | nanoSMDC150F | 1206L150 | SMD1206P150TF |
| ASMD1206-200 | nanoSMDC200F | 1206L200 | SMD1206P200TF |

“PolySwitch” is a registered trademark of Tyco Electronics.

“POLY-FUSE” is a registered trademark of Littelfuse, Inc.

“EVERFUSE” is a registered trademark of Polytronics Technology Corp.

Application Notice

1. Operation of these PPTC devices beyond the stated maximum ratings could result in damage to the devices and lead to electrical arcing and/or fire;

PPTC 器件在超过规定的最大值额定值运行可能会导致器件损坏以及导致电弧和/或火灾。

2. These PPTC devices are intended to protect against the effects of temporary over-current or over-temperature conditions and shall not be taken for use as switch.

PPTC 的作用是防止临时的过流或过温造成的不良影响，不能当作开关使用。

3. Exposure to lubricants, silicon-based oils, solvents, gels, electrolytes, acids, and other related or similar materials may adversely affect the performance of PPTC devices.

PPTC 接触润滑剂、硅基油、溶剂、凝胶、电解质、酸和其他相关或类似材料可能会对 PPTC 器件的性能有不利影响。

4. Circuits with inductance may generate a voltage above the rated voltage of the PPTC device and should be thoroughly evaluated within the user's application during the PPTC selection and qualification process.

带有电感的电路可能产生高于 PPTC 额定电压的电压，因此客户在选型和认定过程中应进行彻底的评估。

5. Please do not smash, clamp, pull, dent or twist by tool during assembling process, as they may result in the PPTC damage.

在装配过程中，避免有砸、挤、拉、扭等方式外力作用于 PPTC 本体上，因为它们可能导致 PPTC 损坏。

6. Hand-soldering of PPTC devices on boards is generally not recommended. Users shall define and verify this process if needed.

不推荐使用手工焊接的方式焊接 PPTC。如果需要，用户需要定义和验证此过程。

7. Recommended storage conditions should be followed at all times, The MSL classification of PPTC is grade 2a. 必须始终遵守推荐的保存条件要求，PPTC 的 MSL 等级为 2 a 级。