

为您的产品保驾护航

PRODUCT DATASHEET

Electro-Static Discharge

JED523-5V-LG ESD

Features

- Package: SOD-523
- Protects one data or power line
- Ultra low leakage: nA level
- Operating voltage: 5V
- Low clamping voltage
- Complies with following standards:
 - IEC 61000-4-2 (ESD) immunity test
Air discharge: $\pm 15\text{kV}$
Contact discharge: $\pm 8\text{kV}$
 - IEC61000-4-5 (Lightning) 2A (8/20 μs)
- RoHS compliant

Applications

- Cellular Handsets and Accessories
- Personal Digital Assistants
- Notebooks and Handhelds
- Portable Instrumentation
- Digital Cameras
- Peripherals
- Audio Players
- Keypads, Side Keys, LCD Displays, USB2.0

Pin Description

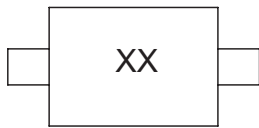

Schematic Diagram

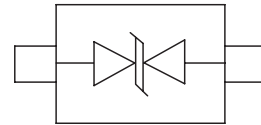

Limiting Values($T_A = 25^\circ\text{C}$, unless otherwise specified)

Symbol	Parameter	Conditions	Value	Unit
V _{ESD}	Electrostatic Discharge Voltage	IEC 61000-4-2; Contact Discharge	± 8	kV
		IEC 61000-4-2; Air Discharge	± 15	kV
T _J	Operating Temperature Range	-	-55 to +125	$^\circ\text{C}$
T _{stg}	Storage Temperature Range	-	-55 to +150	$^\circ\text{C}$

Electrical Characteristics($T_A = 25^\circ\text{C}$, unless otherwise specified)

Symbol	Parameter	Conditions	Min	Typ.	Max	Unit
V _{RWM}	Reverse Working Voltage	$T_A = 25^\circ\text{C}$	-	-	5	V
V _{BR}	Breakdown Voltage	$I_T = 1\text{mA}$	6	-	-	V
I _R	Reverse Leakage Current	$V_{RWM} = 5\text{V}; T_A = 25^\circ\text{C}$	-	-	0.2	μA
V _C	Clamping Voltage	$I_{PP} = 1\text{A} (8 \times 20\mu\text{s pulse})$	-	-	10	V
C _J	Junction Capacitance	$V_R = 0\text{V}, f = 1\text{MHz}$	-	2.5	3.0	pF

Typical Characteristics

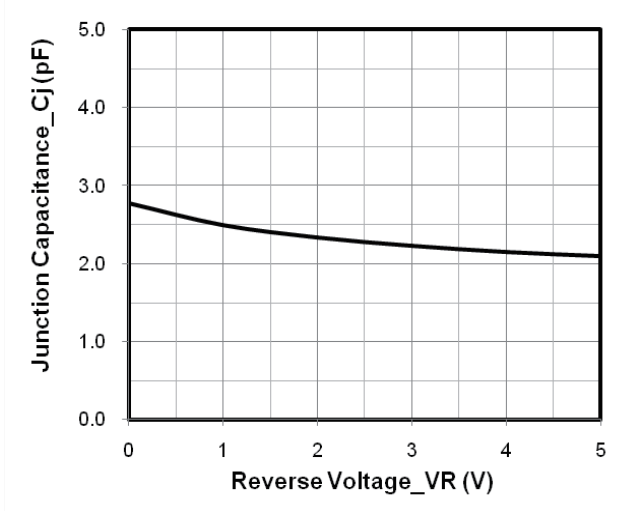

Junction Capacitance vs. Reverse Voltage

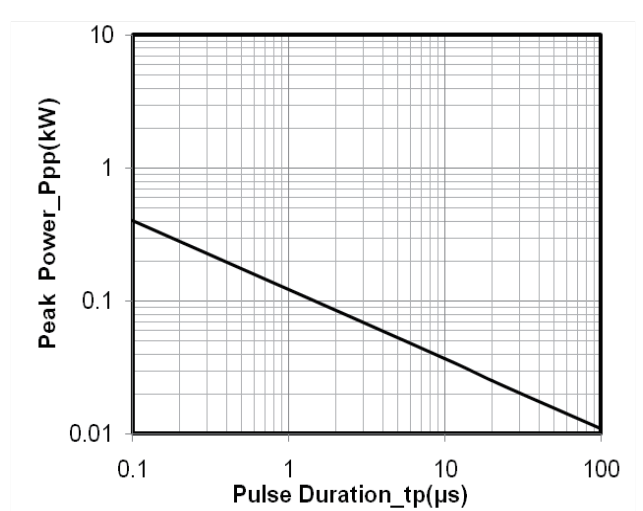

Peak Pulse Power vs. Pulse Time

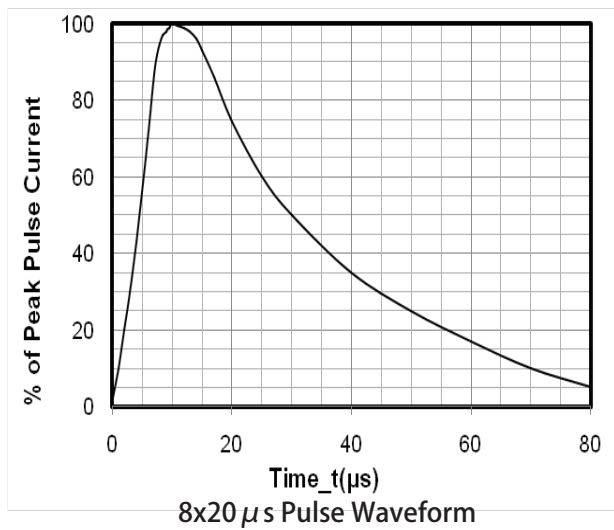

8x20 μs Pulse Waveform

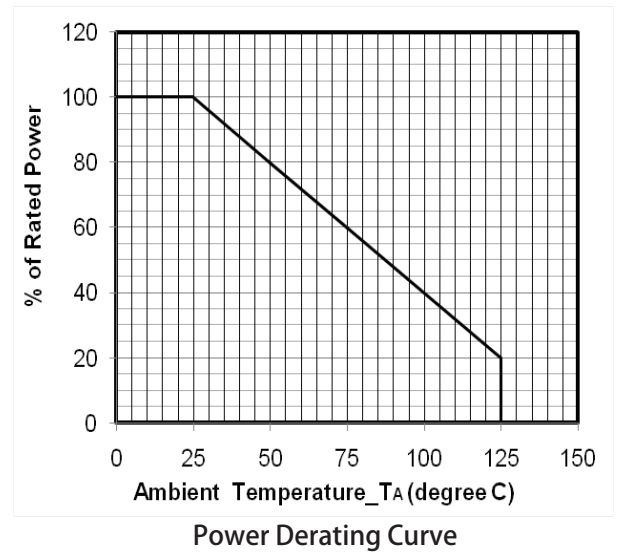

Power Derating Curve

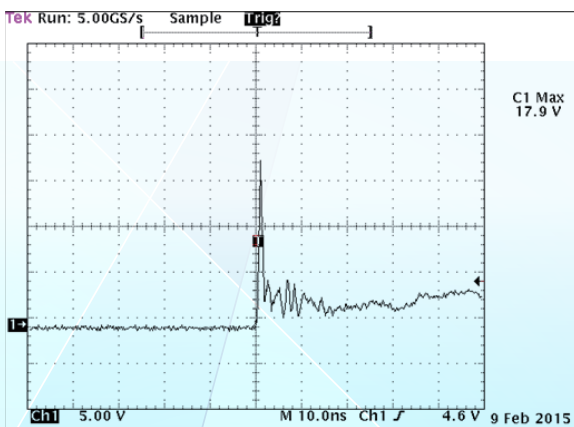

Note: Data is taken with a 10x attenuator
ESD Clamping Voltage
+8 kV Contact per IEC61000-4-2

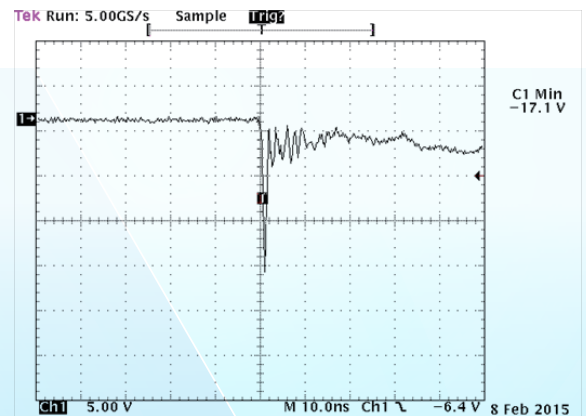

Note: Data is taken with a 10x attenuator
ESD Clamping Voltage
-8 kV Contact per IEC61000-4-2

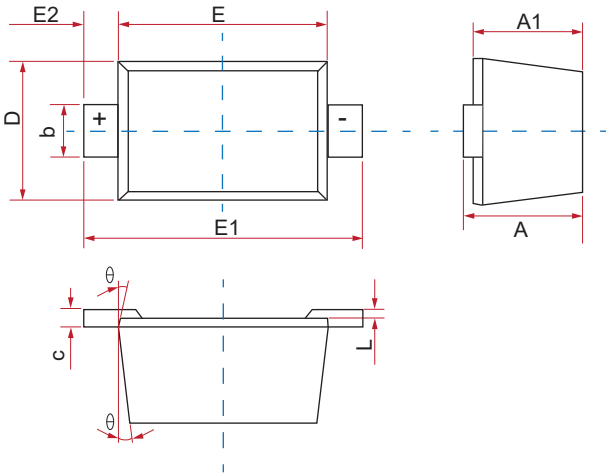
Physical Dimensions(mm.)

Symbol	Dimensions In Millimeters			Dimensions In Inches		
	Min	Nom	Max	Min	Nom	Max
A	0.51	--	0.77	0.020	--	0.031
A1	0.50	--	0.70	0.020	--	0.028
b	0.25	--	0.35	0.010	--	0.014
c	0.08	--	0.15	0.003	--	0.006
D	0.75	--	0.85	0.030	--	0.033
E	1.10	--	1.30	0.043	--	0.051
E1	1.50	--	1.70	0.059	--	0.067
E2	0.20REF			0.008REF		
L	0.01	--	0.07	0.001	--	0.003
θ	7°REF			7°REF		

Suggested Land Pattern

Unit:mm

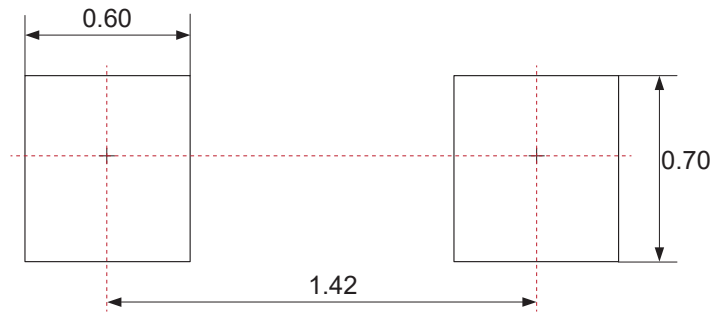
Packaging Quantity

Part Number	Delivery Form	Delivery Quantity
JED523-5V-LC	7"T&R	3,000

Soldering Parameters

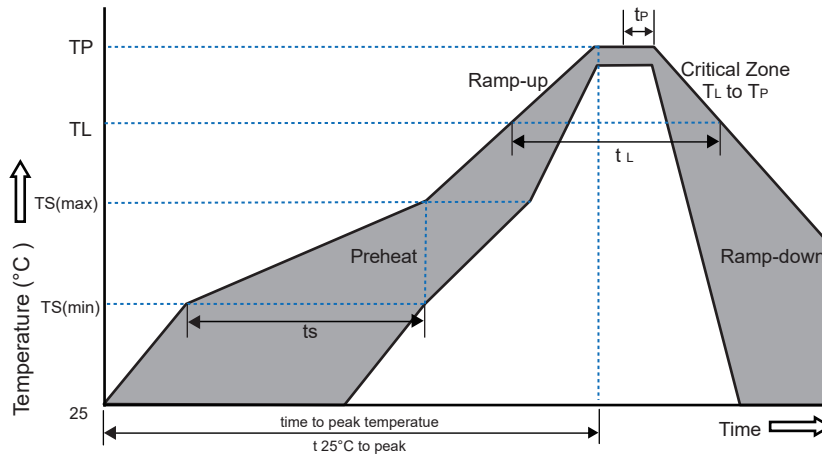

Reflow Condition		Pb-Free Assembly
Pre-heat	-Temperature Min($T_{s(min)}$)	+150°C
	-Temperature Max($T_{s(max)}$)	+200°C
	-Time(Min to Max)(t_s)	60~180 secs.
Average ramp up rate (Liquid us Temp(T_L) to peak)		3°C/sec. Max
Ts(max) to T_L - Ramp-up Rate		3°C/sec. Max
Reflow	-Temperature(T_L)(Liquid us)	+217°C
	-Temperature (t_L)	60~150 secs.
Peak Temp (T_P)		+260(+0/-5)°C
Time within 5°C of actual Peak Temp (t_p)		30 secs. Max
Ramp-down Rate		6°C/sec. Max
xTime 25°C to Peak Temp (TP)		8 min. Max
Do not exceed		+260°C

Part Number System

JE D523 - 5V - L C

